

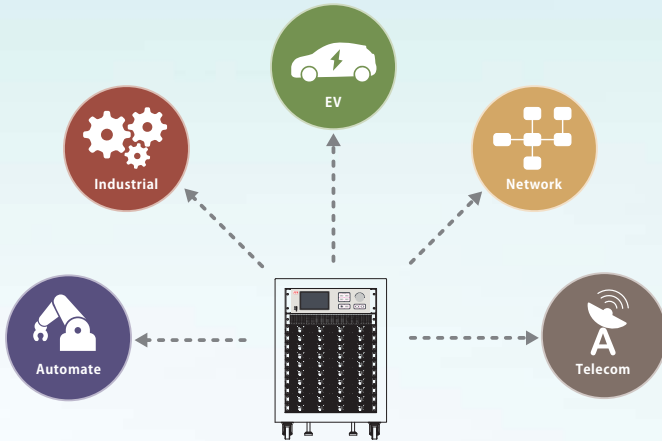

系統電源-電源管理 Installation manual



System Power Solution

• *Integration on power and power management system*

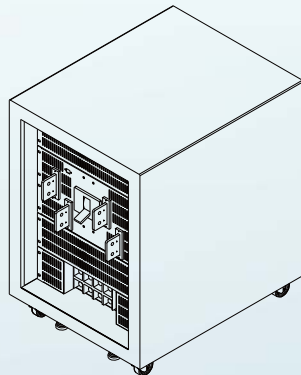
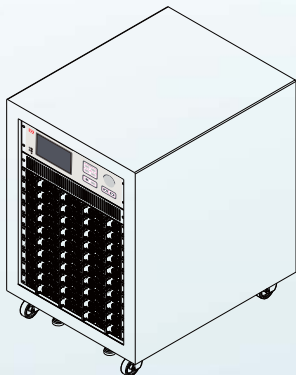



目錄

0.關於此安裝手冊	1
1.安全指南	2
2.安裝	3
2.1 系統櫃資訊	3
2.2 系統電源組裝	4
2.3 系統安裝	4
3.通訊控制	13
4.安裝範例	14
4.1 15U-1U-NCP-128K	14
4.2 22U-2U-SHP-240K	18
5.環境宣告資訊	21
A.附錄	21

0.關於此安裝手冊

- 此系統電源安裝手冊包含系統櫃之安裝指南。
- 使用的安全注意符號。

 警告標示：用於表示會有死亡或嚴重傷害的危險，如果不慎發生的話。

 注意標示：用於表示會有損壞機器或元件的危險，如果不慎發生的話。

 觸電標示：用於表示會有觸電的危險，如果不慎接觸的話。

 高溫警告標示：用於表示會有造成燙傷的危險，如果不慎接觸的話。

1.安全指南

- 安裝機箱到機櫃內至少需要2人或以上。
- 確保工作環境是小於 35°C (95°F)。
- 請不要阻礙任何散熱孔，至少需要15 cm (6 in.)保持通氣流暢。
- 機櫃內請勿遺留開放空間於系統電源上下方。為了避免損壞電源原件，請安裝擋片於開放空間處以幫助機櫃內部空氣循環。
- 機櫃內安裝系統電源請使用帶孔洞的門。
- 設備或系統電源請由機櫃底部向上安裝起。
- 重型設備請只安裝於機櫃底部。
- 請一次只安裝一個設備或系統電源。
- 安裝時請暫時拆除機櫃門或側蓋以利於安裝。
- 系統電源需確實接地。
- 當機櫃內安裝多台系統電源時，請確認輸入線徑足夠承載能量。



≥ 18公斤 (39.7磅)



≥ 32公斤 (70.5磅)



≥ 55公斤 (121.2磅)

2. 安裝

2.1 系統櫃資訊

型號	W	D	H
15U	600	750	912
22U	600	750	1224
30U	600	750	1579
35U	600	750	1801
42U	600	750	2112

Unit : mm

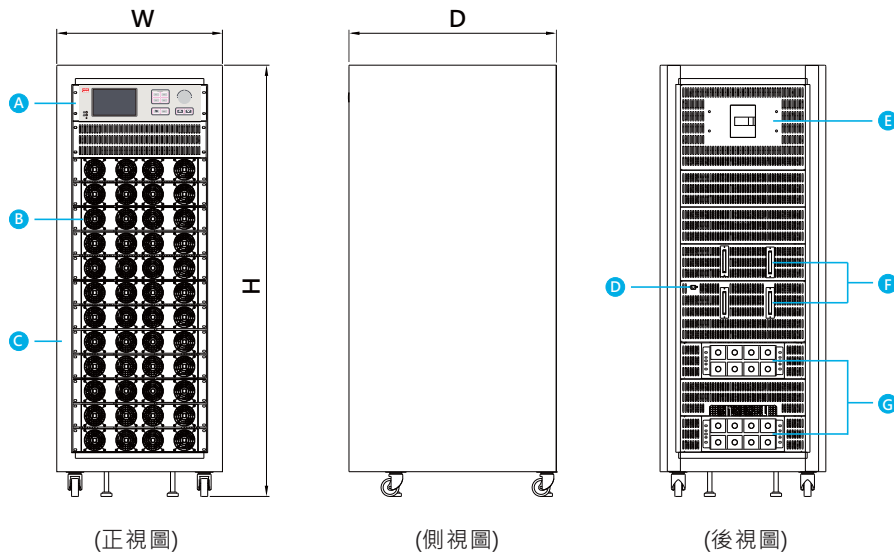

項目	說明	項目	說明
A	CMU2智能控制器	E	交流輸入斷路器
B	電源供應器	F	直流輸出端子
C	機箱	G	交流輸入接線端子
D	RJ-45連接埠		

2.2 系統電源組裝

組裝前請規劃需求瓦數，如有疑問請與明緯工程人員討論。

2.3 系統安裝

2.3.1 前置安裝(Rack Power)

2.3.1.1 NCP-3200系列

進行系統櫃組裝前，請先進行以下DHP-1U-B rack組裝，以利後續步驟。

品名	數量*N (N為安裝台數)
DHP-1UT-B	1*N
NCP-3200	4*N
鎖附配件	2*N
F4*5 螺絲	6*N
輸入連接配件(1GG2FAP-014)	2*N

a. 安裝左右鎖附配件，請設定電動起子扭力磅數為8kgf-cm。

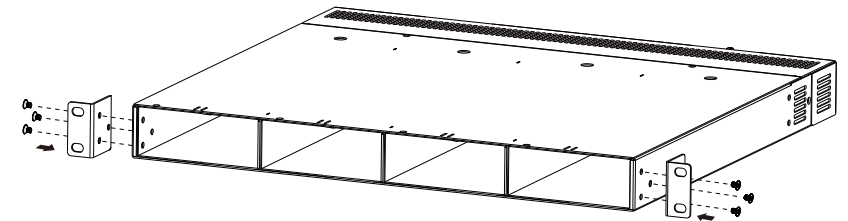

b. 安裝rack後方之輸入連結片(1GG2FAP-014)，請設定電動起子扭力磅數為6kgf-cm。

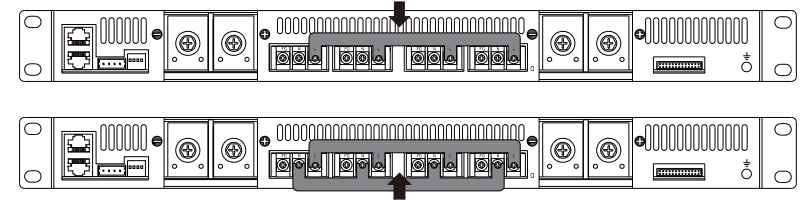

c. 將NCP-3200 PSU置入rack內。

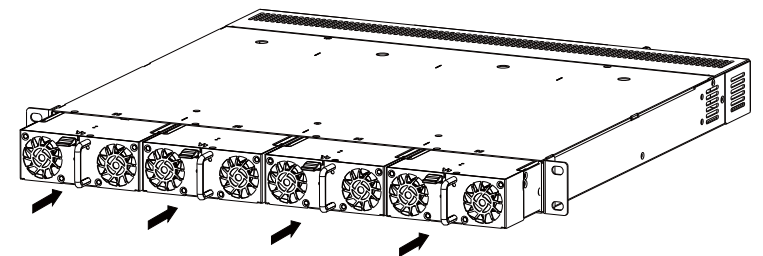

- 單機插入操作: 手握單機把手, 將單機插入機箱即可。



圖3-1 NCP-3200置入機箱示意圖

- 單機拔出操作: 先按單機面板固定彈片(如圖3-2)再做單機拔出動作即可。

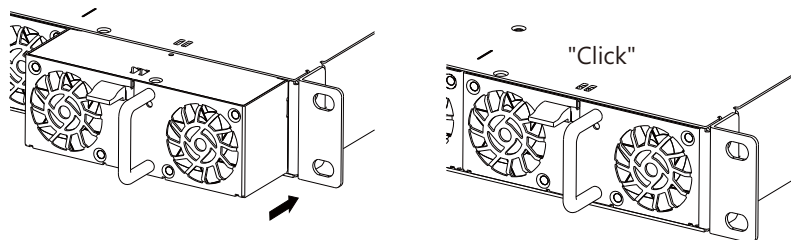

圖3-2 NCP-3200取出機箱示意圖

2.3.1.2 SHP-30K系列

進行系統櫃組裝前, 請先進行以下SHP-30K組裝, 以利後續步驟。

- 安裝左右鎖附配件, 請設定電動起子扭力磅數為8kgf-cm。
- 安裝後直接裝SHP-30K推入機櫃。

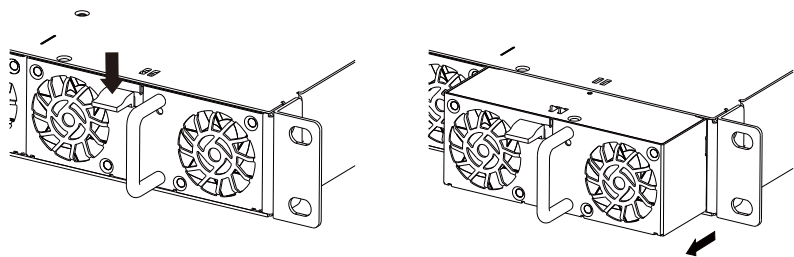
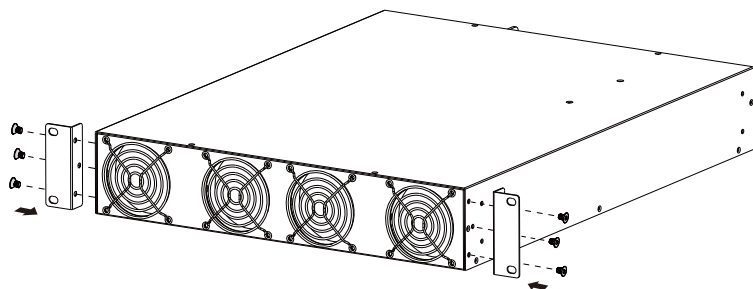

2.3.1.3 機櫃組裝

- 安裝左右支撐架, 鎖附方式如下。請先安裝固定螺母後, 再組裝支撐架, 請設定電動起子扭力磅數為10kgf-cm。

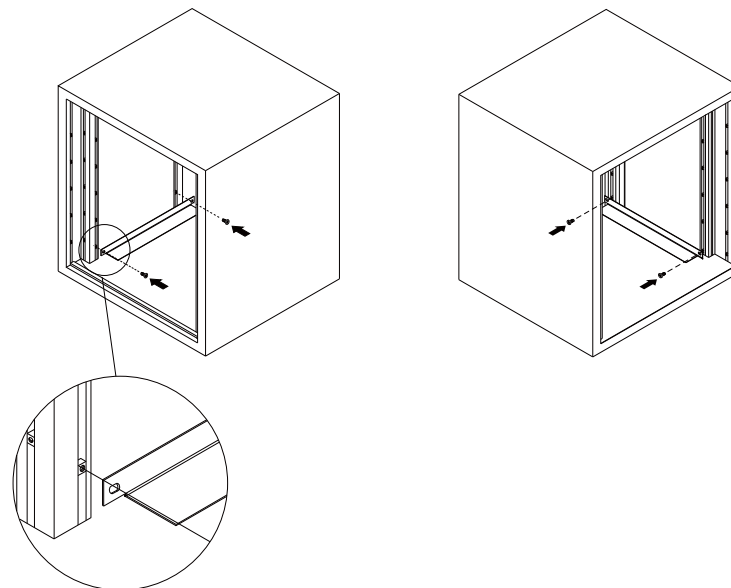

- 置入機箱完成鎖附。

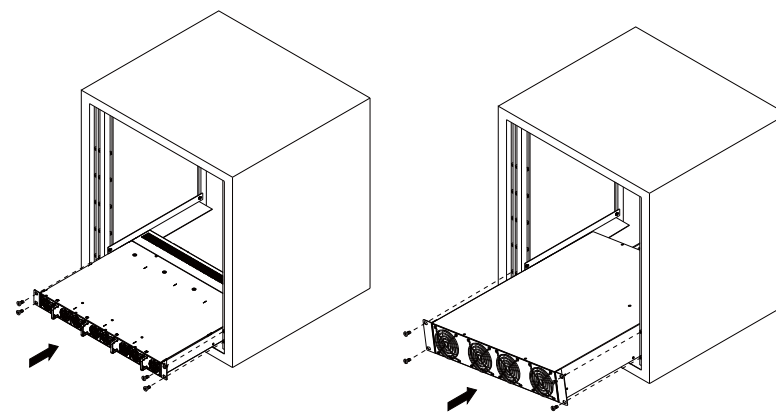

DHP-1UT-B

SHP-30K

c.如多台需安裝，請重複上述步驟。

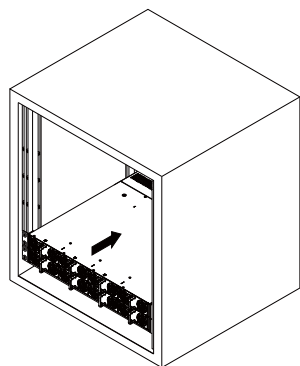

DHP-1UT-B

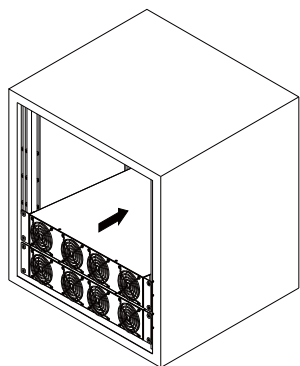

SHP-30K

Note: 支撐架需平貼前組避免影響後續組裝。

d.重複"b." "c." "d." 步驟。直到完成10組DHP-1UT-B/5組SHP-30K。

e.安裝CMU2C於機櫃最上層。

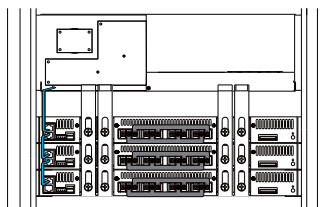

2.3.2 機箱輸出銅排配置

a.鎖附並聯銅排。

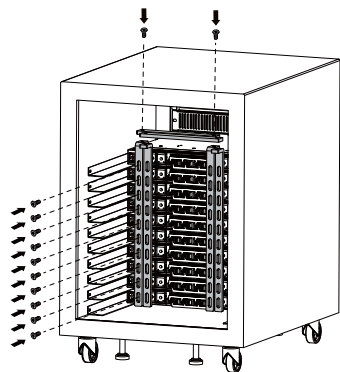

DHP-1UT-B

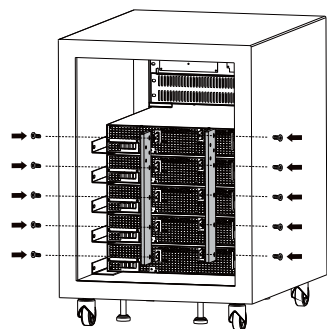

SHP-30K

2.3.2.1 DHP-1UT-B機箱通訊線配置

因單組CMU2C的通訊埠最多只能監控四組DHP-1UT-B。以下將10組DHP-1UT-B分割為四組、三組及三組，各別由三組CMU2C的不同通訊埠控制。

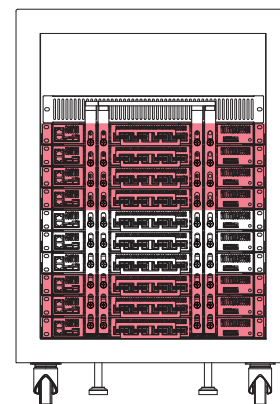

A
B
C

a.各組間機箱使用"1FF5RJ-45-120"連接。

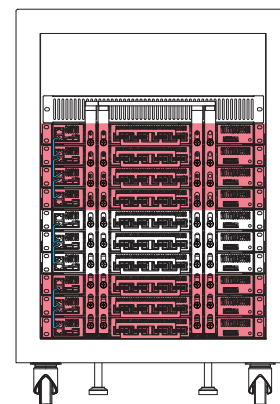

b. 連接A組電源群組至CMU2C通訊A埠。

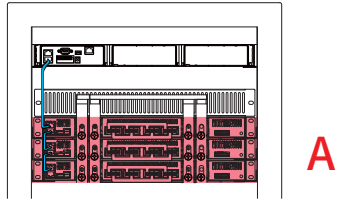

A

c. 設定A/B/C組電源群組address，如下：

Rack No.	SWA Setting				Address or ID			
	1	2	3	4	Module D	Module C	Module B	Module A
0	ON	ON	ON	ON	3	2	1	0
1	OFF	ON	ON	ON	7	6	5	4
2	ON	OFF	ON	ON	11	10	9	8
3	OFF	OFF	ON	ON	15	14	13	12
4	ON	ON	OFF	ON	19	18	17	16
5	OFF	ON	OFF	ON	23	22	21	20
6	ON	OFF	OFF	ON	27	26	25	24
7	OFF	OFF	OFF	ON	31	30	29	28
8	ON	ON	ON	OFF	35	34	33	32

d. 連接B組電源群組至CMU2C通訊B埠。

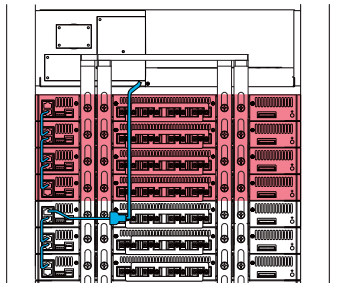

A

B

e. 連接C組電源群組至CMU2C通訊C埠。

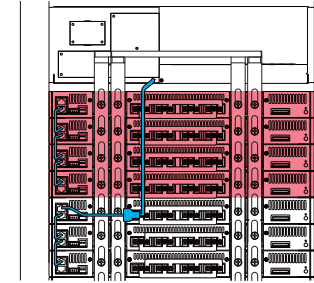

A

B

f. 連接C組電源群組至CMU2C C通訊埠，此步驟不可錯誤。

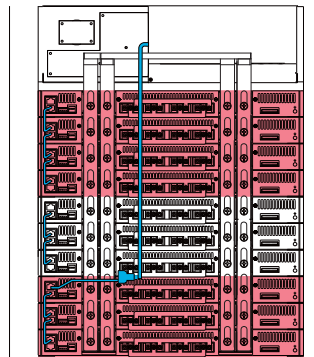

A

B

C

2.3.2.2 SHP-30K機箱通訊線配置

- 使用 "1FF515U-2U-150K" 連接所有SHP-30K與CMU2。
- 設定電源address如下:

Rack No.	SWA Setting			
	1	2	3	4
0	ON	ON	ON	ON
1	OFF	ON	ON	ON
2	ON	OFF	ON	ON
3	OFF	OFF	ON	ON
4	ON	ON	OFF	ON

2.3.3 RST三相輸入配接盤(Rack power only)

2.3.3.1 NCP-3200+DHP-1UT-B

明緯提供RST三相輸入配接裝置，先行配接DHP-1UT-B輸入端並平衡到RST三相內。客戶只需分別配接線材到此配接盤之"R""S""T"輸入即可完成輸入電源的配接。

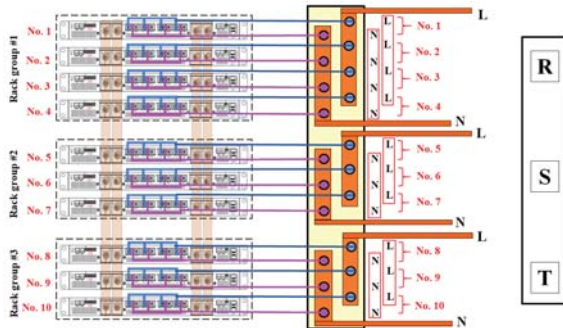

2.3.3.2 SHP-30K

RST三相輸入配線，直接配至產品輸入RST三相內。
線材線徑須滿足產品電流限制。

2.3.4 控制系統

- 進行系統櫃組裝前，請先進行以下RKP-CMU1組裝，以利後續步驟。

品名	數量*N (N為安裝台數)
CMU2C	1
鎖附配件	2
F4*5螺絲	2*N+12
線材"1FF5RJ-45x900" 或線材"1FF5RJ-45Ax850"	N

- 通訊線材配置(A,B,C)及CMU2C電源連接。

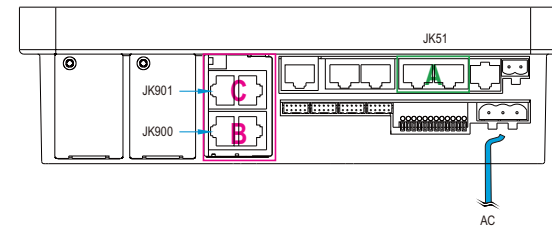

3. 通訊控制

- 明緯系統電源可搭配明緯自製監控器CMU2C，達到控制及監控功能。詳細細節請參考CMU2C規格書及使用手冊。明緯系統電源NCP-3200最多可支援16台同時上線，也就是說單組CMU2C可同時監控NCP-3200 *16pcs。請參考以下內容完成設定。
- Bus上之NCP-3200單體必須要有自己的address設定且每台不一樣。
- 線材連結請確定JK1之SDA/SCL/GND-AUX都有使用，或使用線材"1FF5RJ-45x120"相互連接DHP單體，再以"1FF5RJ-45x900"或1FF5RJ-45Ax850連接至CMU2C，如下所示。

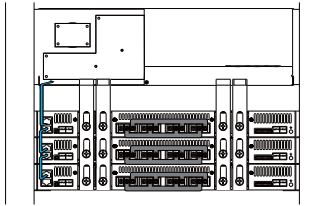



















NCP-3200之7-bits定址方式如下定義。

MSB							LSB
1	0	0	A3	A2	A1	A0	

可由DHP-1UT-B後板之4-pole DIP switch來進行設定。當開關置於上方ON的位置時為邏輯"0"，置於下方OFF位置為邏輯"1"。DIP switch共可指定16個不同的位址，其開關位置與對應之位址，如下表所示。



Module No.	Device address				ON 
	A0	A1	A2	A3	
	DIP switch position				
	1	2	3	4	
0	ON	ON	ON	ON	
1	OFF	ON	ON	ON	
2	ON	OFF	ON	ON	
3	OFF	OFF	ON	ON	
4	ON	ON	OFF	ON	
5	OFF	ON	OFF	ON	
6	ON	OFF	OFF	ON	
7	OFF	OFF	OFF	ON	

Module No.	Device address				ON 
	A0	A1	A2	A3	
	DIP switch position				
	1	2	3	4	
8	ON	ON	ON	OFF	
9	OFF	ON	ON	OFF	
10	ON	OFF	ON	OFF	
11	OFF	OFF	ON	OFF	
12	ON	ON	OFF	OFF	
13	OFF	ON	OFF	OFF	
14	ON	OFF	OFF	OFF	
15	OFF	OFF	OFF	OFF	

Note: 一台CMU2C的通訊埠只能控制四組機架(16台NCP-3200)，超過16台PSU接至其他的通訊埠分群組控制。

4. 安裝範例

4.1 15U-1U-NCP-128K

4.1.1 安裝CMU2C

- 安裝CMU2C機箱於機櫃最上層。

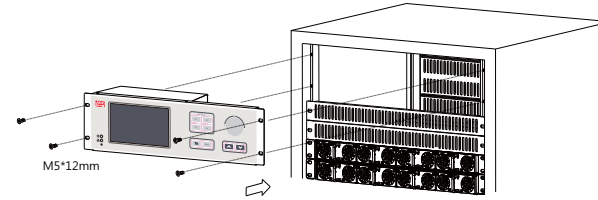

4.1.2 DHP-1UT-B機箱輸出/入線材及通訊線配置

- 鎖附並聯銅錠。

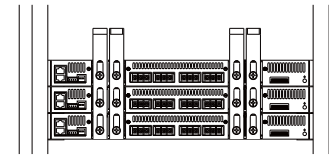

- 連結"1FF5RJ-45x120"及"1FF5RJ-45x900"線材。

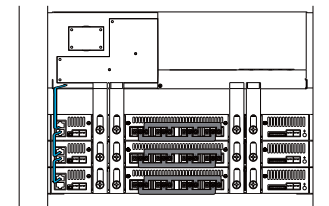

- 安裝終端電阻至最下層DHP-1UT-B機箱。

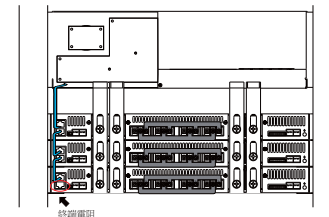

4.1.3 通訊與控制

NCP-3200

其中A5 - A0可用來選擇位址，可由CN1的PIN18 - PIN23進行設定變更。開路: 邏輯1; 當與-V(Singal)(PIN26)短路: 邏輯0。

Address or ID	A5	A4	A3	A2	A1	A0
0	0	0	0	0	0	0
1	0	0	0	0	0	1
2	0	0	0	0	1	0
3	0	0	0	0	1	1
4	0	0	0	1	0	0
5	0	0	0	1	0	1
6	0	0	0	1	1	0
7	0	0	0	1	1	1
8	0	0	1	0	0	0
9	0	0	1	0	0	1
10	0	0	1	0	1	0
11	0	0	1	0	1	1
12	0	0	1	1	0	0
13	0	0	1	1	0	1
14	0	0	1	1	1	0
15	0	0	1	1	1	1
16	0	1	0	0	0	0
17	0	1	0	0	0	1
18	0	1	0	0	1	0
19	0	1	0	0	1	1
20	0	1	0	1	0	0
21	0	1	0	1	0	1
22	0	1	0	1	1	0
23	0	1	0	1	1	1
24	0	1	1	0	0	0
25	0	1	1	0	0	1
26	0	1	1	0	1	0
27	0	1	1	0	1	1
28	0	1	1	1	0	0
29	0	1	1	1	0	1
30	0	1	1	1	1	0
31	0	1	1	1	1	1
32	1	0	0	0	0	0
33	1	0	0	0	0	1
34	1	0	0	0	1	0
35	1	0	0	0	1	1
36	1	0	0	1	0	0

Address or ID	A5	A4	A3	A2	A1	A0
37	1	0	0	1	0	1
38	1	0	0	1	1	0
39	1	0	0	1	1	1
40	1	0	1	0	0	0
41	1	0	1	0	0	1
42	1	0	1	0	1	0
43	1	0	1	0	1	1
44	1	0	1	1	0	0
45	1	0	1	1	0	1
46	1	0	1	1	1	0
47	1	0	1	1	1	1
48	1	1	0	0	0	0
49	1	1	0	0	0	1
50	1	1	0	0	1	0
51	1	1	0	0	1	1
52	1	1	0	1	0	0
53	1	1	0	1	0	1
54	1	1	0	1	1	0
55	1	1	0	1	1	1
56	1	1	1	0	0	0
57	1	1	1	0	0	1
58	1	1	1	0	1	0
59	1	1	1	0	1	1
60	1	1	1	1	0	0
61	1	1	1	1	0	1
62	1	1	1	1	1	0
63	1	1	1	1	1	1

4.1.4 機櫃組裝

a. 連接"1FF5RJ-45x900至CMU2C A。連接"1FF5RJ-45Ax850"至CMU2C B及C。安裝終端電阻至CMU2C A，B及C的額外空埠。

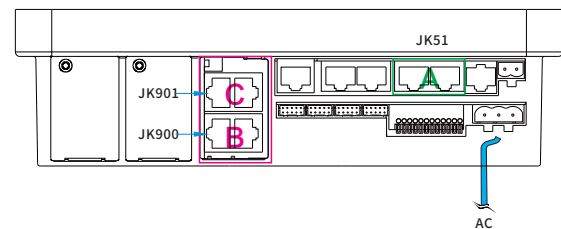

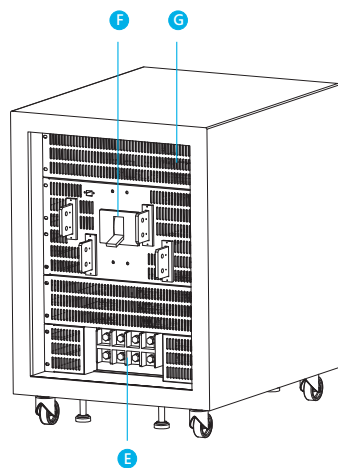
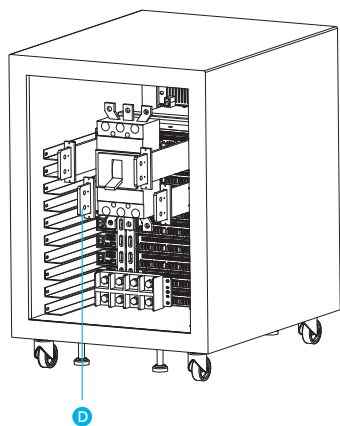
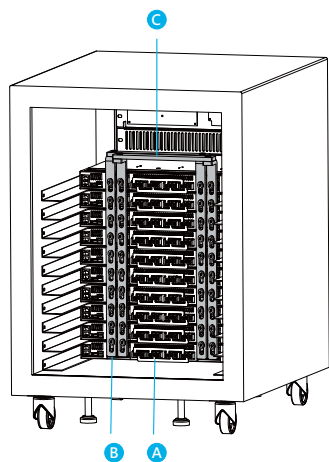

項目	說明	項目	說明
A	AC銅排 *2	E	AC端子台
B	DC銅排A	F	斷路開關
C	DC銅排B	G	側板
D	DC銅排C		

4.2 22U-2U-SHP-240K

4.1.1 安裝CMU2C

a. 安裝CMU2C機箱於機櫃最上層。

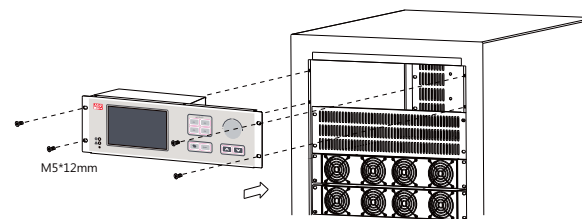

4.1.2 SHP-30K輸出/入線材及通訊線配置

a. 鎖附並聯銅條。

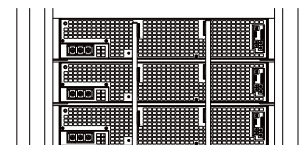

b. 連結CN53連接器。

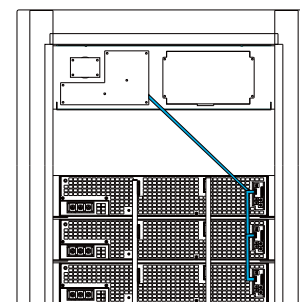

c. 安裝終端電組。

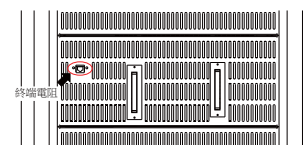

SHP-30K

每台電源設定唯一且不重複之設備位址，其中SW51及SW52可用來選擇位址（最大可指定之位址：64個）。設備位址設定如下所示：

設備編碼	開關位置	
	SW51	SW52
0	0	0
1	0	1
2	0	2
3	0	3
4	0	4
5	0	5
6	0	6
7	0	7
8	0	8
9	0	9
10	1	0
11	1	1
12	1	2
13	1	3
14	1	4
15	1	5
16	1	6
17	1	7
18	1	8
19	1	9
20	2	0
21	2	1
22	2	2
23	2	3
24	2	4
25	2	5
26	2	6
27	2	7
28	2	8
29	2	9
30	3	0
31	3	1

設備編碼	開關位置	
	SW51	SW52
32	3	2
33	3	3
34	3	4
35	3	5
36	3	6
37	3	7
38	3	8
39	3	9
40	4	0
41	4	1
42	4	2
43	4	3
44	4	4
45	4	5
46	4	6
47	4	7
48	4	8
49	4	9
50	5	0
51	5	1
52	5	2
53	5	3
54	5	4
55	5	5
56	5	6
57	5	7
58	5	8
59	5	9
60	6	0
61	6	1
62	6	2
63	6	3

SHP-30K機箱功能說明

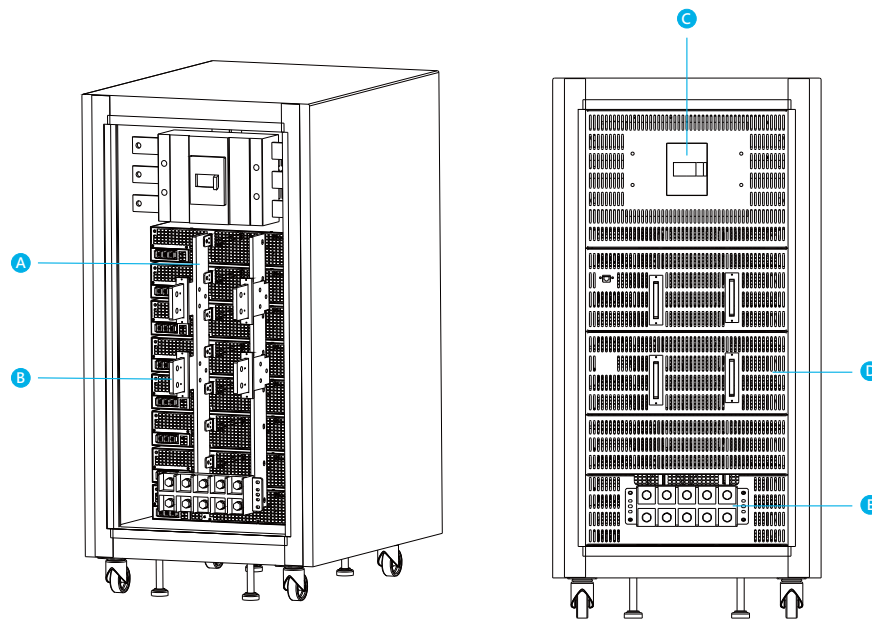

項目	說明	項目	說明
A	DC銅排A *2	D	側板
B	DC銅排B *4	E	AC端子台
C	AC斷路開關		

5.環境宣告資訊

https://www.meanwell.com//Upload/PDF/RoHS_PFOS.pdf



https://www.meanwell.com//Upload/PDF/REACH_SVHC.pdf

https://www.meanwell.com//Upload/PDF/Declaration_RoHS-C.pdf

A 附錄

A1 配件

A1.1 並聯連結配件

Output Parallel Connection Accessory	
1GG2FAP-011	
1GG2FAP-012	
1GG2FAP-013	

A1.2 並聯連結線材

1FF5RJ-45x120

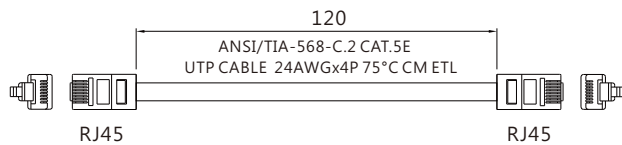

1FF5RJ-45x900

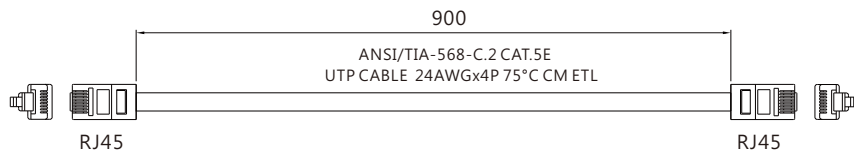

A1.3 輸入連結配件

Input Parallel Connection Bus Link	
1GG2FAP-014	

A1.4 支撐架

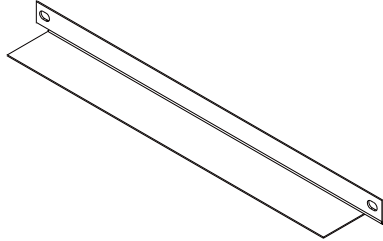
Mounting Angle	
PGG7RA27904 (2pcs/set)	

A1.5 機櫃層板

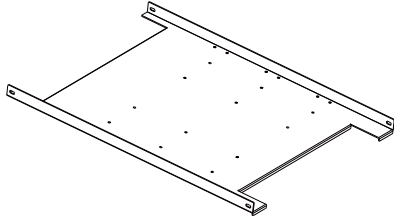
Cabinet Blank Panel	
PGG7RAF9AH01	

A1.6 通風板

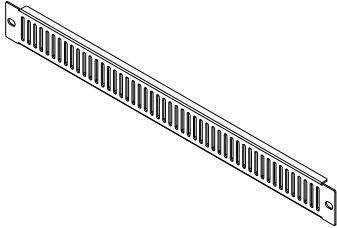
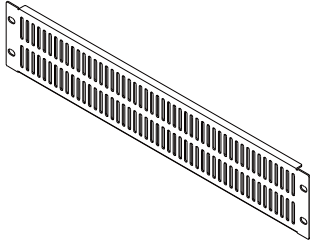
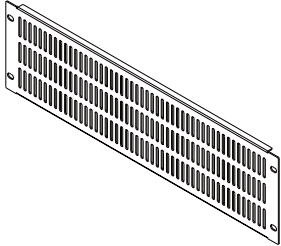
Rack Panel	
PGG7RD9AR01U (1U Rack Panel)	
PGG7RD9AR02U (2U Rack Panel)	
PGG7RD9AR03U (3U Rack Panel)	

A1.7 空白面板

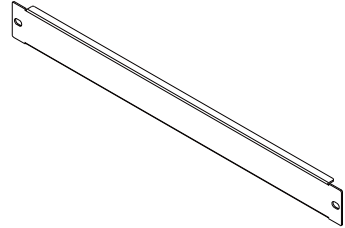
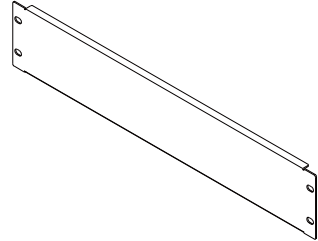
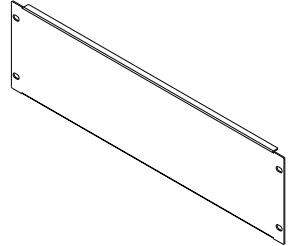
Rack Panel	
PGG7RD9AQ01U (1U Rack Panel)	
PGG7RD9AQ02U (2U Rack Panel)	
PGG7RD9AQ03U (3U Rack Panel)	

明緯企業股份有限公司

MEAN WELL ENTERPRISES CO., LTD.

248 新北市五股區五權三路28號

No.28, Wuquan 3rd Rd., Wugu Dist., New Taipei City 248, Taiwan

Tel:886-2-2299-6100 Fax:886-2-2299-6200

<http://www.meanwell.com> E-mail:info@meanwell.com